



**2 YEAR WARRANTY** (RESTRICTIONS APPLY)

Imada, Inc. warrants its products to the original purchaser to be free from defects in workmanship and material under normal use and proper maintenance for two years (one year for adapters, attachments, batteries, and cables) from original purchase. This warranty only covers defective material and labor and does not cover calibration, freight, fees and expenses and shall not be effective if the product has been subject to overload, shock load, improper battery charging, misuse, negligence, accident or repairs attempted by others than Imada, Inc.

During the warranty period, we will, at our option, either repair or replace defective products. Please call our customer service department for a return authorization number and return the defective product to us with freight prepaid.

The foregoing warranty constitutes the **SOLE AND EXCLUSIVE WARRANTY**, and we hereby disclaim all other warranties, express, statutory or implied, applicable to the products and/or software, including but not limited to all implied warranties of merchantability, fitness, non-infringement, results, accuracy, security and freedom from computer virus. In no event shall Imada, Inc. and/or its affiliated companies be liable for any incidental, consequential or punitive damages in connection with the use of its products and/or software.

# **CEDAR**

## **TORQUE MEASUREMENT**

# **Digital Torque Tester**

## **for impact drivers & air tools**

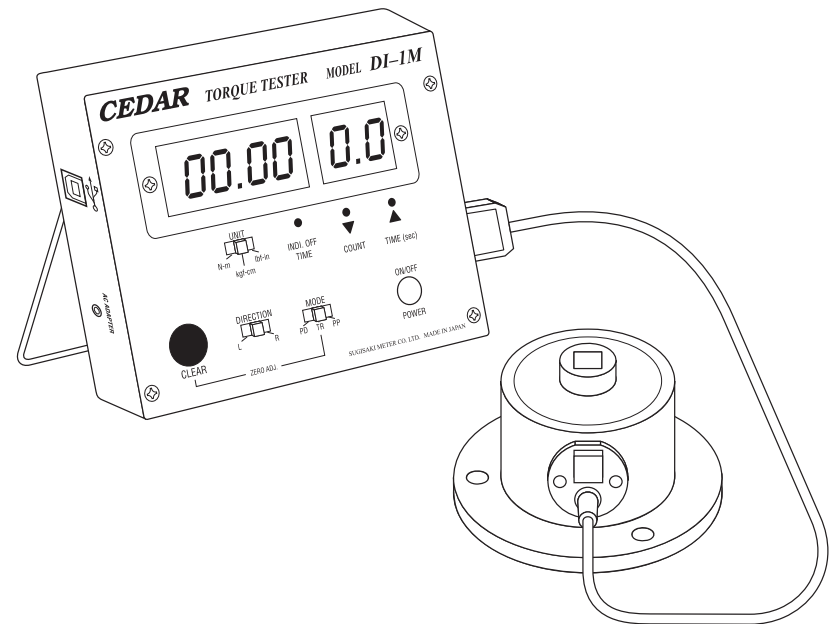

**Model: DI-1M v-62334**

# **INSTRUCTION MANUAL**



## SPECIFICATIONS

DI-1M Ranges Accuracy: ±0.5% F.S. ±1 LSD

Model	lbf-in	kgf-cm	N-m
DI-1M-50	3.0~440.0	3.0~500.0	30~5000 (N-cm)
DI-1M-200A	30~1800	30~2000	3.0~200.0

Model	lbf-ft	kgf-m	N-m
DI-1M-200	3.0~145.0	0.30~20.00	3.0~200.0
DI-1M-500	3.0~362.0	0.30~50.00	3.0~500.0

## LIST OF EQUIPMENT

- ① Torque Tester Display Unit
- ② Torque Sensor
- ③ Cable
- ④ AC adapter/charger
- ⑤ Units designator

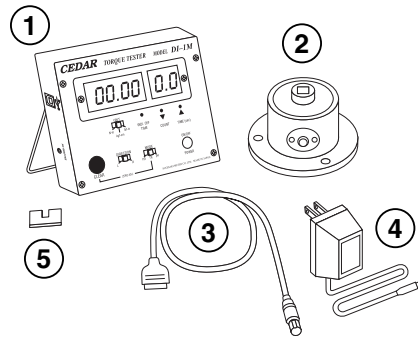

## READ FIRST: SAFETY INFORMATION

For safety, and for damage avoidance, be sure to read this manual thoroughly. The warranty is only valid when the product is used following the instructions provided within this manual.

- Do not use tester in high temperature, high humidity, or in damp or wet areas.
- Recommended operating temperature is between 0-42°C (32-100°F).
- Do not apply torque exceeding the rated capacity, regardless of whether the unit is On or Off.
- When charging the battery, be sure to use the provided AC adapter/charger exclusively.
- When measuring torque, the unit will have a tendency to turn. In order to avoid spinning and possible accident, it is very important to securely mount the unit to a stable work bench.
- Do not use lacquer thinner or any solvent to clean the unit.
- Do not disassemble or modify the unit.



## DIMENSIONS

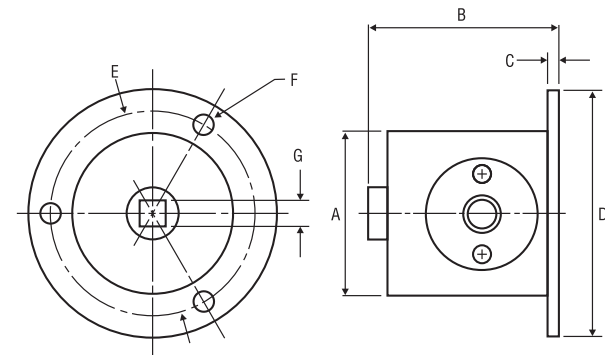
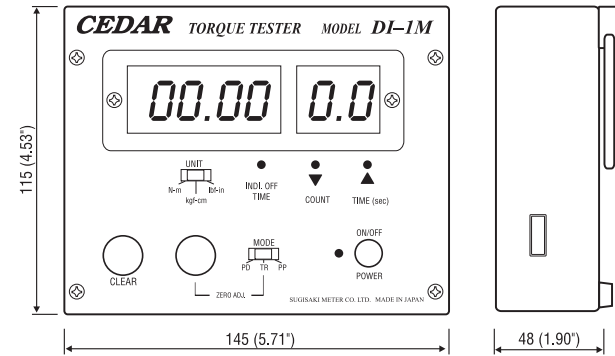

	A	B	C	D	E	F	G
DI-1M-50IP	∅50 (1.97")	63 (2.48")	10 (.39")	∅90 (3.54")	∅76 (2.99")	∅6.5 (.26")	9.5 (3/8" Female Drive)
DI-1M-200IP	∅60 (2.36")	72 (2.83")	10 (.39")	∅110 (4.33")	∅90 (3.54")	∅9.0 (.35")	12.7 (1/2" Female Drive)
DI-1M-500IP	∅80 (3.15")	99 (3.89")	15.5 (.61")	∅140 (5.51")	∅116 (4.57")	∅10.5 (.41")	19 (3/4" Female Drive)



DI-1M-IP SPECIFICATIONS			
	DI-1M-IP50	DI-1M-IP200	DI-1M-IP500
<b>Measuring Range</b>	0.30 50 N-m 3.0 500 kgf-cm 3.0 430 lbf-in	3.0 200 N-m 30 2000 kgf-cm 30 1800 lbf-in	3.0 500 N-m 30 5000 kgf-cm 30 4500 lbf-in
<b>Peak Down Operating Range</b>	0.70N-m 7.0kgf-cm/lbf-in	7.0N-m 70kgf-cm/lbf-in	
<b>Accuracy</b>	±0.5 F.S.		
<b>Display</b>	4 digit LED		
<b>Operation</b>	Both CW and CCW		
<b>Measuring Modes</b>	P-P Peak Mode displays PEAK torque value that will not change until a higher value is measured. T-R Real Time Mode displays TRANSIENT torque values. P-D Output Torque Data every 1/87 seconds.		
<b>Auto Clear</b>	Automatically zero the display, 0.5 - 3.0 sec, selectable at 0.5 sec intervals (0.0 sec for manual)		
<b>Blow Measurement</b>	0 - 99 blows; 0.1 - 9.9 seconds		
<b>Data Output</b>	ASCII format (baud rate 19,200)		
<b>Power Supply</b>	Ni-Cad rechargeable battery 1.2Vx5cells (700mAh)		
<b>Auto Shut Off</b>	Automatic shut off after 5 minutes of non-use		
<b>Charging Time</b>	8 hours		
<b>Working Time</b>	8 hours continuous		
<b>Meter Weight</b>	Approx. 600g		
<b>Sensor Weight</b>	Approx. 600g	Approx. 1kg	Approx. 2.5kg
<b>Meter Dimensions</b>	146mm(W) x 115mm(D) x 48mm(H)		
<b>Accessories</b>	Carrying case, AC/DC adapter		

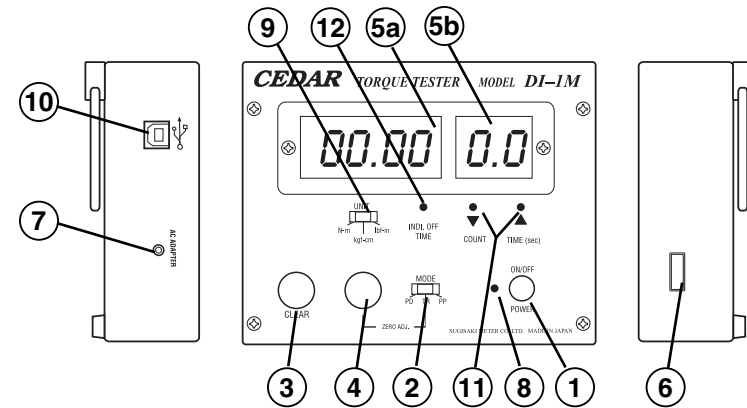

- ① **ON/OFF Switch** Press to turn on, press again to turn off (click once, do not hold). After 10 minutes of non-use the unit shuts off.
- ② **Mode Select Switch**  
**PD (Peak Down):** To capture critical first peak value.  
**C (Real Time):** To display torque transients.  
**PP (Peak):** To capture peak torque achieved during a test.
- ③ **CLEAR Switch** To reset the display or output peak data
- ④ **Zero Adjustment Pot.**
- ⑤ **LED Display** Displays torque and low battery icon (LOBAT).
- ⑤a **Torque Value**
- ⑤b **Number of Blows**
- ⑥ **Sensor Cable Receptacle**
- ⑦ **AC Charger/Adapter Receptacle** If LOBAT icon appears, 8-hour battery recharge is required.
- ⑧ **System Reset Button** When battery has been depleted completely and a recharge has been executed, the system may not yet work. In this case, press the System Reset Button.
- ⑨ **Unit Switch** To select measuring units (lbf-in, kgf-cm & N-cm)
- ⑩ **USB port (Virtual RS-232 Output)**
- ⑪ **Blow Counter Duration Timer** Use a paper clip to push the switches, right to increase, left to decrease.
- ⑫ **Auto Zero Reset Switch**



## GENERAL OPERATION

**IMPORTANT!** Always make sure that the sensor is mounted securely to a stable workbench to avoid spinning and possible accident.

1. Connect the torque sensor to the tester display unit with cable provided. When connecting the cable to the torque sensor, rotate the round connector to find the matching groove, then push in until it makes positive connection (When disconnecting the cable, hold the silver metal part of the round connector and pull out).
2. Select measuring unit (lbf-in/lbf-ft, kgf-cm/ kgf-m, or N-cm/N-m). If desired, affix unit designator to prevent it from being accidentally changed.
3. Select among the following Measurement Modes (For normal testing, PP mode is recommended).

**PP (Peak Mode):** Capture peak torque PEAK Torque reading will not change until a higher value is measured (peak data output).

**C (Real Time Mode):** Display torque transient (no output).

**PD (Peak Down Mode):** Capture first peak value and will not change even if a higher value is subsequently measured (peak data output).

4. Press ON/OFF, if the unit does not display zero, select TR mode and use the Zero Adjustment Pot. ④ to make sure the display reads zero.
5. Select Peak Mode (PP) or Peak Down mode (PD).
6. The blow counter counts the number of pulses for a specified time, up to 9.9 seconds. The counter works in PP mode only. Set the time duration by using a pointed tool like a paperclip to push the switches ①, right to increase, left to decrease.
7. Insert wrench drive securely into the sensor, hold perpendicularly (not at an angle), and turn on the tool to measure.
8. After taking measurement, press CLEAR ③ to zero the display for the next test.

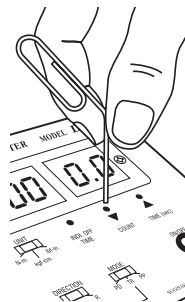
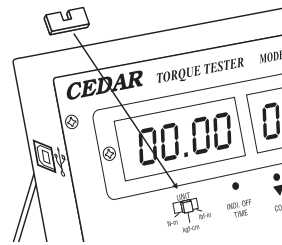

## Optional Data Acquisition Software SW-1SV-USB

SW-1SV-USB is a highly customized Excel spreadsheet specifically designed for capturing and analyzing real-time data from Cedar torque instruments with a USB port. SW-1SV-USB provides a running log of all measurements along with a graph and statistical information including min, max, mean, median, standard deviation, average deviation and variance.

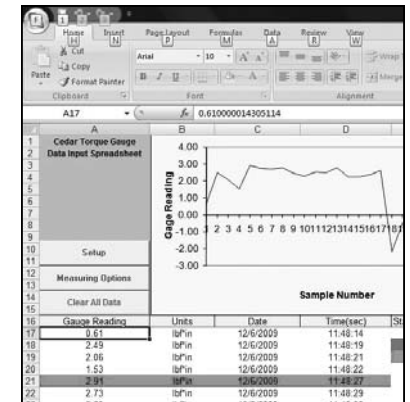

### Requirements

1. PC computer with Windows XP or later and Excel 2000 or later.
2. CB-208 or CB-209 cable



### Virtual RS-232C Serial Output

Output is available in PD, PP and C modes. In PD and PP modes peak data is output when ZERO is pressed or activated by the AUTO ZERO function.

#### Comport signal

8 data, 2 stop, no parity. Baud Rate: 19,200 bps.

#### Output Connector

USB A/B cable

#### Peak Data Output Format

[CAN] \_ \_ \_ [SO] [value] \_ [SI] [unit] [CR]

(\_ \_ \_ is memory location)

[CAN]: ASCII control code 24

\_ : Space (code 32)

[SO]: ASCII control code 14

[value]: Output data with sign and decimal point. Plus sign represents for CW torque and minus sign for CCW. [Value] always occupy six locations and empty locations will be filled with spaces.

[SI]: ASCII control code 15

[unit]: N\*m \_ \_ \_ = N·m  
kgf\*cm = kg·cm  
lb\*in \_ = lb·in

[CR]: ASCII control code 13 (Carriage Return)

#### Continuous Output Data Format

[CAN] [value] [CR]



### Auto Zero Reset Switch *for Peak or Peak Down mode*

Rather than resetting manually for each test, the Automatic Zero Reset can be programmed by using a paperclip to push the Auto Zero Reset Switch ⑫.

As the Auto Zero Reset Switch ⑫ is pressed (use a pointed tool, like a paperclip end), the Automatic Zero Reset durations cycle. (0.0C → 0.5C → 1.0C → 1.5C → 2.0C → 2.5C → 3.0C) Select the desired duration. For example, 0.5C means 0.5 second and 0.0C means MANUAL RESET. If a selection is not made within 3 seconds, the cycle begins again.

#### Auto Power Off

To maximize the life of the battery, power will automatically shut off after 10 minutes of non-use.

#### System Reset Button

When battery has been depleted completely and a recharge has been executed, the system may not yet work. In this case, press the System Reset Button ⑧.

#### Low Battery Indicator

“-L- -” will appear when tester needs to be recharged. Turn off power.

**IMPORTANT!** Use the provided IMADA/CEDAR AC adapter/charger exclusively and plug into the correct AC output. It takes 8 hours to charge fully. Do not recharge for more than 12 hours. When it is fully charged, make sure the AC adapter/charger is disconnected to avoid overcharging.

In order to avoid high heat, explosion or toxic fumes, please note the following precautions:

Be sure to use the provided AC charger exclusively.  
Do not plug the charger into unspecified higher voltage.  
Do not recharge until LOBAT icon appears.



## OUTPUT

### USB Virtual COM Port

When the tester is connected to a computer's USB port and turned on, Windows XP or Vista will recognize the tester and ask to connect to the Internet. Allow Windows Update to connect to the Internet and follow the instructions on your screen to download and install two drivers for the USB virtual com port. For Windows 98, ME and MAC go to [www.ftdichip.com/Drivers/VCP.htm](http://www.ftdichip.com/Drivers/VCP.htm).



The PC and tester will communicate through the USB port the same as a com port. To verify the COM port number open the Device Manager.

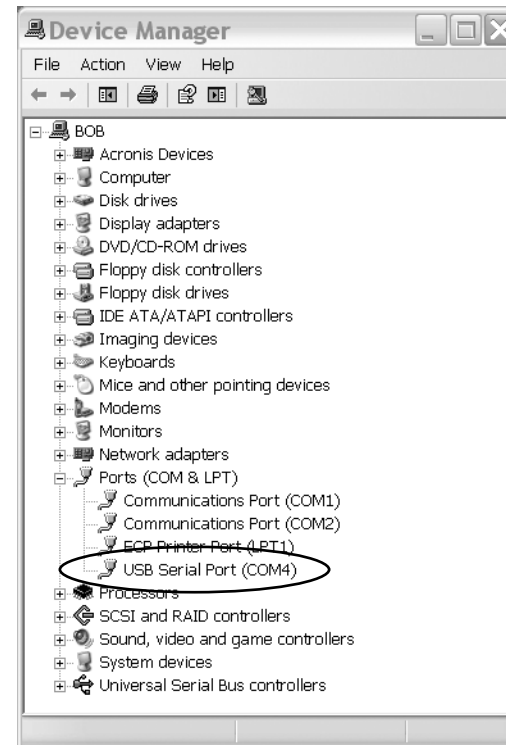

Output is available in PD, PP and C modes. In PD and PP modes peak data is output when ZERO is pressed or activated by the AUTO ZERO function. In C mode, the gauge outputs data continuously 180 data/second.